

A3 Colour MFP

BP-50C45

Future proofed by design with stringent security features and superior functionality for hybrid working



- 45ppm colour MFP with seamless integration and connection to cloud based business process applications
- Built-in Microsoft® Teams connector strengthens collaboration by enabling direct and secure access for printing to or scanning from your Microsoft® Teams channels
- Keep your data, device and network secure with optional Bitdefender anti-malware protection software
- Securely print from or scan to public cloud storage services quickly and easily with single sign-on
- Extensive finishing options including a folding unit bring even more flexibility to your print output
- Keep up-to-date and compliant with remote firmware and application updates via the Sharp Application Portal
- Feature rich hardware and solutions platform that supports the hybrid working environment
- Industry leading system and data protection features including BIOS based security and standard Trusted Platform Module ensure that confidential data is kept secure
- Interact with the MFP directly from your mobile device via Bluetooth, using QR codes or optional WiFi, AirPrint and NFC
- 10.1-inch colour LCD operation panel offers a smartphone style user interface making everything easy to access and use
- Superior environmental performance delivers lower standby power consumption and low TEC value
- 100-sheet Reversing Single Pass Feeder scans one or two-sided originals at speeds of up to 80ipm for completing large jobs with ease and efficiency

Configurations

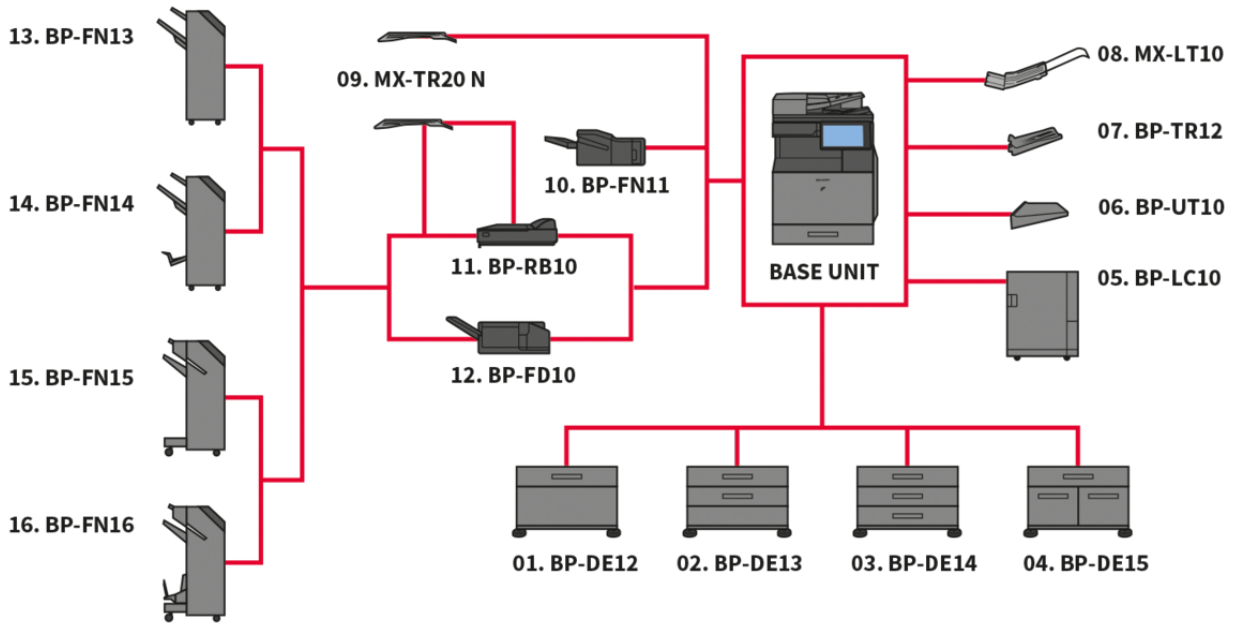

Configurations may differ per sales region. Please contact your local Sharp representative for further information.

Dimensions

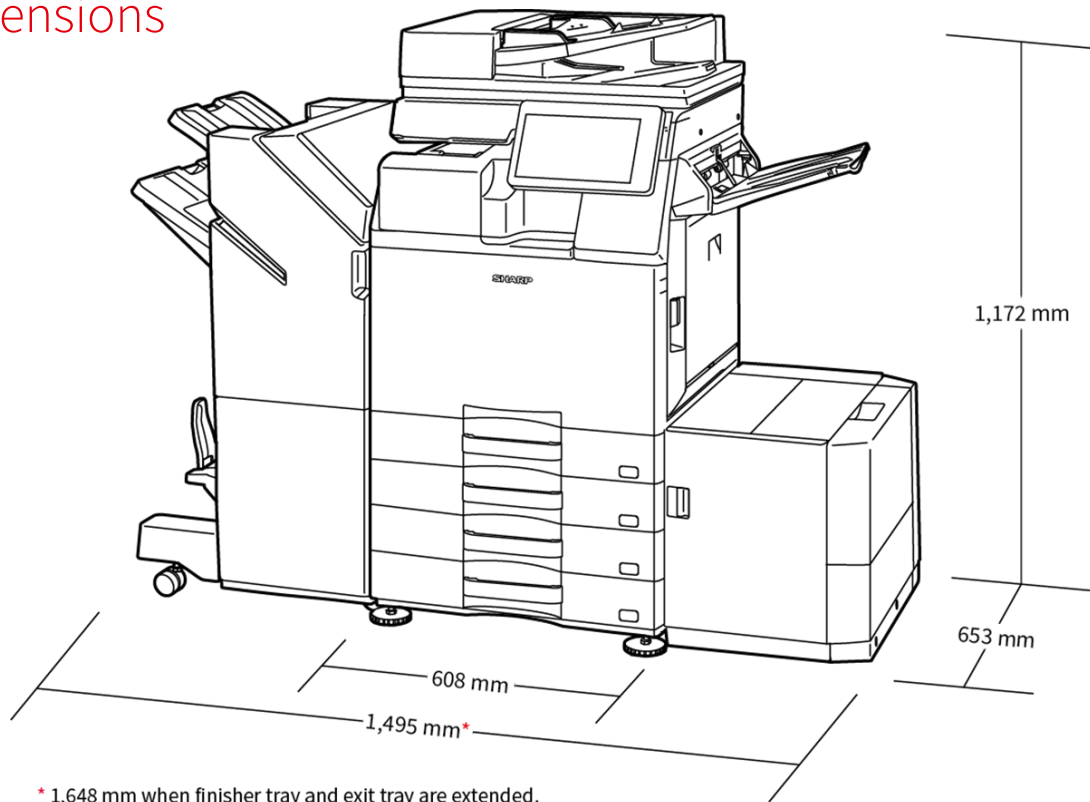

* 1,648 mm when finisher tray and exit tray are extended.

Dimensions are shown with optional equipment. Options may differ per region.

Options

Base Unit

01. BP-DE12 Stand with 550-sheet paper drawer

550 sheets* , SRA3 to A5R (60 - 300 g/m2)

02. BP-DE13 Stand with 2 x 550-sheet paper drawer

550 sheets* each for lower and upper trays, SRA3 to A5R (60 - 300 g/m2)

03. BP-DE14 Stand with 3 x 550-sheet paper drawer

550 sheets* each for lower and upper trays, SRA3 to A5R (60 - 300 g/m2)

04. BP-DE15 Stand with 550 + 2100-sheet paper drawer

Upper tray: SRA3 - A5R, 550 sheets* (60 - 300 g/m2)

Lower tray (Left): A4, 1,200 sheets* (60 - 105 g/m2)

Lower tray (Right): A4 - B5, 900 sheets* (60 - 105 g/m2)

05. BP-LC10 Large Capacity Tray

3,000 sheets* , A4 - B5 (60 - 220 g/m2)

06. BP-UT10 Utility Table

Printing

MX-PK13 PS3 Expansion Kit

Enables PostScript printing

MX-PU10 Direct Print Expansion Kit

MX-PF10 Barcode Font Kit

Enables barcode printing

Scanning

MX-EB19 Enhanced Compression Kit

Enables creation of high compression PDFs

MX-EB20 OCR Expansion Kit

AR-SU1 Stamp Unit

Marks already scanned documents for checking

Faxing

BP-FX11 Fax Expansion Kit

MX-FWX1 iFax Expansion Kit

Connectivity

BP-EB10 Wireless Connection Adaptor

Enables connection to wireless networks

Storage

BP-SD10 High Capacity SSD

512GB SSD

Sharp OSA®

MX-AMX1 Application Integration Module

BP-AM10 Application Communication Module

BP-AM11 External Account Module

Security

BP-FR12U Data Security Kit

Commercial version

BP-VD10 Virus Detection Kit

Finishing

07. BP-TR12 Exit Tray Unit

08. MX-LT10 Long Paper Feeding Tray

Recommended for banner printing

09. MX-TR20 N Job Separator Tray

Requires BP-TU10 Exit Tray Cabinet

10. BP-FN11 Inner Finisher

A3 - B5 (offset/staple), SRA3 - A5R (non offset)

Offset tray (upper): max. 500-sheet paper capacity*

Stapling capacity: max. 50-sheet multi-position staple*

Manual Stapling: 1-point at rear (Flat), 45 sheets (64 g/m2), 40 sheets (80 g/m2)

Stapleless capacity: max.10-sheet (64 g/m2), 8 sheet (65 - 81.4 g/m2), 6 sheet (81.5 - 105 g/m2)

11. BP-RB10 Paper Pass Unit

Required when using BP-FN13, BP-FN14, BP-FN15 & BP-FN16

12. BP-FD10 Folding Unit

200 sheets* , A3, B4, A4R (Z-fold & half fold), A3, A4R (C-Fold, Accordion fold), 60 - 256 g/m2

13. BP-FN13 1k Finisher

A3W - A5R (offset/staple), SRA3 - A5R (non offset)

Offset tray (upper): max.1,000-sheet paper capacity*

Stapling capacity: max. 50-sheet multi-position staple*

14. BP-FN14 1k Saddle Stitch Finisher

A3W - A5R (offset/staple), SRA3 - A5R (non offset)

Offset tray (upper): max.1,000-sheet paper capacity*

Stapling capacity: max. 50-sheet multi-position staple*

Saddle stitch tray (lower): 7 sets (11-15 sheets), 10 sets (6-10 sheets), 20 sets (1-5 sheets). 15 sheets max per set

15. BP-FN15 3k Finisher

A3 - B5 (offset/staple), SRA3 - A5R (non offset)

Offset tray (upper): max.3,000-sheet paper capacity*

Stapling capacity: max. 65-sheet multi-position staple*

Manual Stapling: 1-point at rear (Flat), 45 sheets (64 g/m2), 40 sheets (80 g/m2)

Stapleless capacity: max.10-sheet (64 g/m2), 8 sheet (65 - 81.4 g/m2), 6 sheet (81.5 - 105 g/m2)

16. BP-FN16 3k Saddle Stitch Finisher

A3 - B5 (offset/staple), SRA3 - A5R (non offset)

Offset tray (upper): max.3,000-sheet paper capacity*

Stapling capacity: max. 65-sheet multi-position staple*

Manual Stapling: 1-point at rear (Flat), 45 sheets (64 g/m2), 40 sheets (80 g/m2)

Stapleless capacity: max.10-sheet (64 g/m2), 8 sheet (65 - 81.4 g/m2), 6 sheet (81.5 - 105 g/m2)

Saddle stitch tray (lower): 10 sets (11-20 sheets), 15 sets (6-10 sheets), 25 sets (1-5 sheets). 20 sheets max per set

MX-PN14C/D Punch Modules (2/4, 4 wide) for BP-FN11

MX-PN15C/D Punch Modules (2/4, 4 wide) for BP-FN13/BP-FN14

MX-PN16C/D Punch Modules (2/4, 4 wide) for BP-FN15/BP-FN16

* Number of sheets based on 80 g/m2

Specifications

GENERAL

Engine speed Colour ppm (A4)	45
Engine speed B/W ppm (A4)	45
Engine speed Colour ppm (A3)	21
Engine speed B/W ppm (A3)	21
Paper size: Min.-Max.	A6R - SRA3
Paper weight (g/m2)	55 - 300
Paper capacity:Std (sheets)	650
Paper capacity: Max. (sheets)	6300
Warm Up Time (sec.)	16
Memory general min/max (GB)	5
SSD	STD / OPT
SSD Capacity (GB)	128 / 512
Duplex	STD
Power requirements - rated local AC voltage (Hz)	220 - 240V, 50 / 60Hz
Power consumption (kW)	1.84
Dimensions (mm)	608 x 653 x 829
Weight (kg)	78

DOCUMENT FEEDER

Original capacity (sheets)	100
----------------------------	-----

DOCUMENT FILING

Document filing (Standard / Option)	STD
Document filing capacity- main and custom folders (pages)	20000
Document filing capacity- quick file folder (pages)	10000
Stored jobs	Copy, print, scan, fax transmission
Storage folders	Quick file folder, main folder, custom folder (max. 1000)

FAX

Fax (Standard / Option)	OPT
Compression method	MH / MR / MMR / JBIG
Communication protocol	Super G3 / G3
Transmission time (sec)	2
Modem Speed (bps)	33600 - 2400
Transmission resolution	STD 203.2 x 97.8 dpi / Ultra Fine 406.4 x 391 dpi
Document Size (Min)	A5
Document Size (Max)	A3
Memory (GB)	4
Grey Scale levels	256
Dial Registration; rapid/speed dial	2000
Broadcast Transmission (max. destinations)	500

WIRELESS LAN

Wireless LAN (Standard / Option)	OPT
Compliant regulation	IEEE802.11 a / b / g / n / ac
Access mode	Infrastructure mode, Software AP mode
Security	WEP, WPA / WPA2-mixed PSK, WPA / WPA2-mixed EAP, WPA2-PSK, WPA2-EAP, WPA2 / WPA3-mixed PSK / SAE, WPA3 SAE, WPA2 / WPA3-mixed EAP, WPA3 EAP

COPIER

Original paper size (Max.)	A3
First copy out time Colour (sec.)	6.5
First copy out time B/W (sec.)	4.6
E-sort Std	•
Continuous copy (Max. copies)	9,999
Resolution Scan B/W (dpi)	600 x 600, 600 x 400
Resolution Scan Colour (dpi)	600 x 600
Resolution Print (dpi)	1200 x 1200, 600 x 600, 9600 x 600
Gradation (equivalent levels) - Colour	256
Zoom range (%)	25 - 400
Preset copy ratios	10

SCANNER

Network Scanner (Standard / Option)	STD
Scan method Push scan and Pull scan	•
Resolution push scan (dpi)	100, 150, 200, 300, 400, 600
Resolution pull scan (dpi)	75, 100, 150, 200, 300, 400, 600, 50 - 9600
File formats	TIFF, PDF, PDF / A-1a, PDF / A-1b, encrypted PDF, compact PDF, JPEG, XPS, searchable PDF, Microsoft Office (pptx, xlsx, docx), TXT (UTF-8), RTF
Scan destinations Desktop	•
Scan destination FTP, Email	•
Scan destination Network folder	•
Scan destination USB memory	•

PRINTER

Resolution (dpi)	1200 x 1200, 600 x 600, 9600 x 600
Network Printer (Standard / Option)	STD Ethernet
Interface Std/Opt	USB 2.0, USB 3.0, 10Base-T / 100Base-TX / 1000Base-T
Supported OS Standard	Windows 8.1, 10, 11. Windows Server 2012, 2012R2, 2016, 2019.
Supported OS Options	Mac OS X 10.10, 10.11, 10.12, 10.13, 10.14, 10.15, 11, 12
Network protocols	TCP / IP (IPv4, IPv6)
Printing protocols	LPR, Raw TCP (port 9100), POP3 (e-mail printing), HTTP, FTP for downloading print files, IPP, SMB, WSD
PDL Std/Opt	STD PCL 6. OPT Adobe® PostScript® 3™
Available fonts	80 (PCL), 139 (Adobe PostScript 3)

FINISHING

Output Capacity Max.	500 - 3000
Staple Capacity (sheets) Max.	65
Saddle Stitch	OPT
Off-set shifting	STD
Hole punch	OPT

TONER YIELD

Black (pages at 5% coverage)	40000
Cyan (pages at 5% coverage)	24000
Magenta (pages at 5% coverage)	24000
Yellow (pages at 5% coverage)	24000

Design and specifications are subject to change without prior notice. All information was correct at time of print. Microsoft, Excel, PowerPoint, OneDrive, SharePoint, Active Directory, Windows Server, and Windows are either registered trademarks or trademarks of Microsoft Corporation in the US and/or other countries. Adobe and PostScript 3 are either registered trademarks or trademarks of Adobe Systems Incorporated in the US and/or other countries. Google Drive, Gmail and Android are trademarks of Google LLC. The Google Drive trademark is used with permission from Google LLC. Box is a trademark, service mark, or registered trademark of Box, Inc. QR Code is a registered trademark of DENSO WAVE INCORPORATED in Japan and other countries. AirPrint and Mac are trademarks of Apple Inc., registered in the US and other countries. PCL is a registered trademark of Hewlett-Packard Company. Qualcomm DirectOffice is a product of Qualcomm Technologies, Inc. and/or its subsidiaries. Qualcomm is a trademark of Qualcomm Incorporated, registered in the US and other countries. DirectOffice is a trademark of CSR Imaging US, LP, registered in the US and other countries. All other company names, product names and logotypes are trademarks or registered trademarks of their respective owners. ©Sharp Corporation March 2022. Ref: BP-50C45 Datasheet. All trademarks acknowledged. E&O.